

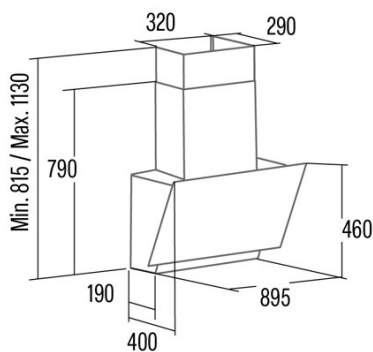

# THALASSA 900 GWH

Cod. **02139006**

EAN **8422248356251**



## GENERAL INFORMATION

EAN/UPC	8422248356251
Subfamily	Angle Glass

### Product sheet according to directives EU65/2014 - EN61591, EN60704-2-13, EN50564

AEC (Annual energy consumption) (kWh/year)	58,6
EEl class (energy efficiency class)	A
FDE (fluid dynamic efficiency)	29,4
FDE class (fluid dynamic efficiency class)	A
LE (light efficiency) (Lux/W)	23,7
LE class (light efficiency class)	B
GFE (grease filtering efficiency)	75,5
GFE class (grease filtering efficiency class)	C
Airflow in normal mode MIN (m3/h)	346
Airflow in normal mode MAX (m3/h)	600
Airflow in boost mode MIN (m3/h)	811
Acoustic power in normal mode MIN (dB)	50
Acoustic power in normal mode MAX (dB)	65
Acoustic power boost mode (dB)	67
Po (energy consumption in off mode) (W)	0
Ps (energy consumption in standby mode) (W)	0,43

### Integration directive EU 66/2014

f (time increase factor)	0,9
EEl (Energy Efficiency Index)	52,7
QBEP (maximum efficiency at air flow point) (m3/h)	457,2
PBEP (maximum efficiency at pressure point) (Pa)	397
WBEP (power consumption at maximum efficiency) (W)	171,6
WL (nominal power lighting system) (W)	3
EMIDDLE (Average illuminance on the cooking surface) (lux)	71

### External Dimensions

Width (mm)	900
Depth (mm)	375
Maximum total height (mm)	1130
Minimum total height (mm)	815
Diamètre de sortie (mm)	150

### Characteristics

Motor quantity	1
Motor model	BT3
Maximum pressure (Pa)	450
Filter technology	Aluminium mesh
Control technology	Electronic Touch Control
Booster	√
Power levels	6
Timer	√
Filter saturation indicator	√
Charcoal filter replacement indicator	√
Dimmer function	√
Connectivity	√
Remote control	-
Display	Display

### Lighting

Light model	SSLED
Ray technology	LED

### Installation

Minimum distance to electric plate (mm)	450
Minimum distance to gas plate (mm)	650

Recirculation option	√
Charcoal filter	√
Back draught shutter	No
Inner shield	-

---

**Electric connection**

Nominal voltage (V)	220-240
Nominal frequency (Hz)	50/60
Nominal input power (W)	283
Electric shock protection	Class II
Plug type	No plug

---

**Accessories**

Upper decorative duct extension	02861300
White decorative duct	02861001
Black decorative duct	02861401
Back draught shutter	02832004
Activated charcoal filter	02859398
Noiseless flexible duct	02893002
Recirculation kit	02800013

---