

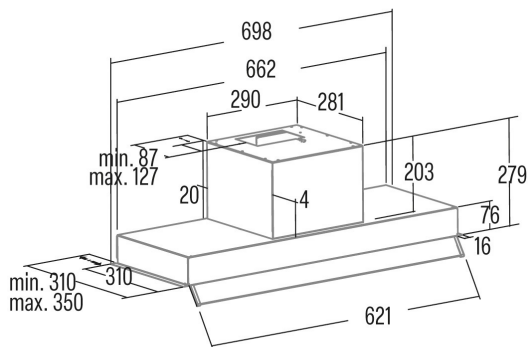

# ARMONIA 70 BK

Cod. **02187409**

EAN **8422248356015**



## GENERAL INFORMATION

EAN/UPC	8422248356015
Subfamily	Integrated

## Product sheet according to directives EU65/2014 - EN61591, EN60704-2-13, EN50564

AEC (Annual energy consumption) (kWh/year)	100,9
EEl class (energy efficiency class)	C
FDE (fluid dynamic efficiency)	16,3
FDE class (fluid dynamic efficiency class)	D
LE (light efficiency) (Lux/W)	21,4
LE class (light efficiency class)	B
GFE (grease filtering efficiency)	64,8
GFE class (grease filtering efficiency class)	D
Airflow in normal mode MIN (m3/h)	385
Airflow in normal mode MAX (m3/h)	645
Acoustic power in normal mode MIN (dB)	56
Acoustic power in normal mode MAX (dB)	70
Po (energy consumption in off mode) (W)	0
Ps (energy consumption in standby mode) (W)	0

## Integration directive EU 66/2014

f (time increase factor)	1,4
EEl (Energy Efficiency Index)	82,4
QBEP (maximum efficiency at air flow point) (m3/h)	375,3
PBEP (maximum efficiency at pressure point) (Pa)	295
WBEP (power consumption at maximum efficiency) (W)	188,8
WL (nominal power lighting system) (W)	6
EMIDDLE (Average illuminance on the cooking surface) (lux)	269

## External Dimensions

Width (mm)	698
Depth (mm)	310
Maximum total height (mm)	280
Minimum total height (mm)	280
Diamètre de sortie (mm)	150, 125

## Characteristics

Motor quantity	1
Motor model	TA
Maximum pressure (Pa)	430
Filter technology	Aluminium mesh
Control technology	Mechanical push button
Booster	-
Power levels	3
Timer	-
Filter saturation indicator	-
Charcoal filter replacement indicator	-
Dimmer function	-
Connectivity	No
Remote control	-
Display	-

## Lighting

Light model	CSLED
Ray technology	LED

## Installation

Minimum distance to electric plate (mm)	450
Minimum distance to gas plate (mm)	650
Recirculation option	-
Charcoal filter	-

Back draught shutter	No
Inner shield	-

---

**Electric connection**

Nominal voltage (V)	230-240
Nominal frequency (Hz)	50
Nominal input power (W)	276
Electric shock protection	Class II
Plug type	No plug

---

**Accessories**

Upper decorative duct extension	02861307
Activated charcoal filter	02859392
Noiseless flexible duct	02893002

---