

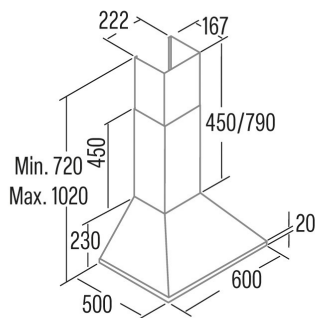

OMEGA 600 BK

Cod. 02002410

EAN 8422248109833



GENERAL INFORMATION

EAN/UPC	8422248109833
Subfamily	Chimney

Product sheet according to directives EU65/2014 - EN61591, EN60704-2-13, EN50564

AEC (Annual energy consumption) (kWh/year)	95,4
EEl class (energy efficiency class)	C
FDE (fluid dynamic efficiency)	17,8
FDE class (fluid dynamic efficiency class)	D
LE (light efficiency) (Lux/W)	33,3
LE class (light efficiency class)	A
GFE (grease filtering efficiency)	90,3
GFE class (grease filtering efficiency class)	B
Airflow in normal mode MIN (m3/h)	385
Airflow in normal mode MAX (m3/h)	645
Acoustic power in normal mode MIN (dB)	57,8
Acoustic power in normal mode MAX (dB)	71,8
Po (energy consumption in off mode) (W)	0
Ps (energy consumption in standby mode) (W)	0

Integration directive EU 66/2014

f (time increase factor)	1,4
EEl (Energy Efficiency Index)	81,3
QBEP (maximum efficiency at air flow point) (m3/h)	371,8
PBEP (maximum efficiency at pressure point) (Pa)	314
WBEP (power consumption at maximum efficiency) (W)	182,5
WL (nominal power lighting system) (W)	3
EMIDDLE (Average illuminance on the cooking surface) (lux)	100

External Dimensions

Width (mm)	600
Depth (mm)	500
Maximum total height (mm)	890
Minimum total height (mm)	600
Diamètre de sortie (mm)	150, 125

Characteristics

Motor quantity	1
Motor model	TA
Maximum pressure (Pa)	430
Filter technology	Aluminium mesh
Control technology	Mechanical push button
Booster	-
Power levels	3
Timer	-
Filter saturation indicator	-
Charcoal filter replacement indicator	-
Dimmer function	-
Connectivity	-
Remote control	-
Display	-

Lighting

Light model	CSLED
Ray technology	LED

Installation

Minimum distance to electric plate (mm)	650
Minimum distance to gas plate (mm)	650
Recirculation option	√
Charcoal filter	-

Back draught shutter	No
Inner shield	-

Electric connection

Nominal voltage (V)	220-240
Nominal frequency (Hz)	50
Nominal input power (W)	273
Electric shock protection	Class II
Power cord length (m)	0,7
Plug type	No plug

Accessories

White decorative duct	No
Black decorative duct	No
Island tube booster	No
Back draught shutter	02832001
Activated charcoal filter	02859391
Noiseless flexible duct	02893002
Recirculation kit	02894000
