

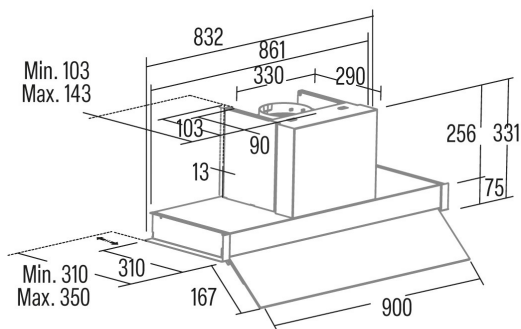

TENTA 900 XGWH

Cod. **02189005**

EAN **8422248093729**



GENERAL INFORMATION

EAN/UPC	8422248093729
Subfamily	Integrated

Product sheet according to directives EU65/2014 - EN61591, EN60704-2-13, EN50564

AEC (Annual energy consumption) (kWh/year)	24,7
EEl class (energy efficiency class)	AP
FDE (fluid dynamic efficiency)	37,5
FDE class (fluid dynamic efficiency class)	A
LE (light efficiency) (Lux/W)	23,7
LE class (light efficiency class)	B
GFE (grease filtering efficiency)	62,7
GFE class (grease filtering efficiency class)	E
Airflow in normal mode MIN (m3/h)	245
Airflow in normal mode MAX (m3/h)	509,4
Airflow in boost mode MIN (m3/h)	765,3
Acoustic power in normal mode MIN (dB)	46
Acoustic power in normal mode MAX (dB)	63
Acoustic power boost mode (dB)	67
Po (energy consumption in off mode) (W)	0,49
Ps (energy consumption in standby mode) (W)	0

Integration directive EU 66/2014

f (time increase factor)	0,7
EEl (Energy Efficiency Index)	40,3
QBEP (maximum efficiency at air flow point) (m3/h)	346,6
PBEP (maximum efficiency at pressure point) (Pa)	298
WBEP (power consumption at maximum efficiency) (W)	76,6
WL (nominal power lighting system) (W)	7
EMIDDLE (Average illuminance on the cooking surface) (lux)	166

External Dimensions

Width (mm)	900
Depth (mm)	310
Maximum total height (mm)	331
Minimum total height (mm)	331
Diamètre de sortie (mm)	150

Characteristics

Motor quantity	1
Motor model	BT4DC
Maximum pressure (Pa)	357
Filter technology	Aluminium mesh
Control technology	Electronic Touch Control
Booster	√
Power levels	6
Timer	√
Filter saturation indicator	√
Charcoal filter replacement indicator	-
Dimmer function	√
Connectivity	√
Remote control	-
Display	Display_grafico

Lighting

Light model	SSLED BICOLOR
Ray technology	LED

Installation

Minimum distance to electric plate (mm)	450
Minimum distance to gas plate (mm)	650

Recirculation option	√
Charcoal filter	-
Back draught shutter	-
Inner shield	-

Electric connection

Nominal voltage (V)	220-240
Nominal frequency (Hz)	50
Nominal input power (W)	146
Electric shock protection	Class I
Plug type	No plug

Accessories

Upper decorative duct extension	No
White decorative duct	No
Black decorative duct	No
Island tube booster	No
Back draught shutter	2832008
MAX PRO Metal filter	No
Activated charcoal filter	2859399
Noiseless flexible duct	2893002
Recirculation kit	No
